

■ ACESSÓRIOS

A 20X

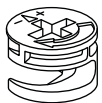

TAMBOR GIROFIX

B 20X



PAR GIROFIX

C 08X

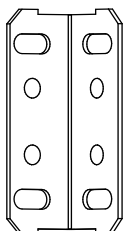

CANTONEIRA 4 FUROS

D 12X

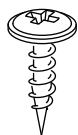

PAR FLANG
3,5X14 mm

E 27X

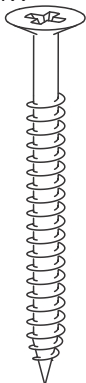

PAR CHATO 5,0X50 mm

F 01X

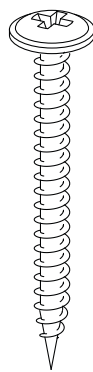

PAR FLANG 5X40 mm

G 04X

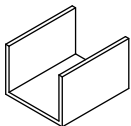

SAPATA U

H 03X

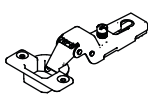

DOBRADIÇA

I 03X

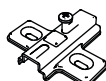

CALÇO

J 40X



PREGO 10X10 mm

K 01X

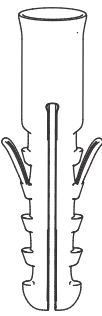

BUCHA
8mm

L 36X



PAR CHATO
3,5X12 mm

M 01X

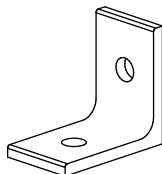

CANTONEIRA
PLÁSTICA

N 01X



PAR CHATO
3,5X14

O 01X

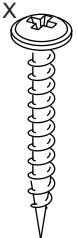

PAR FLANG
3,5X30 mm

■ RELAÇÃO DE PEÇAS

PEÇA	QTD.	DESCRIÇÃO	MEDIDAS	MATERIAL
1	01	RODAPE FRONTAL	660X85X15	MDP
2	02	RODAPE LATERAL	320X85X15	MDP
3	01	RODAPE TRASEIRO	660X85X15	MDP
4	01	BASE	680X360X15	MDP
5	01	LATERAL ESQUERDA	1700X340X15	MDP
6	05	PRATELEIRA MAIOR	435X338X15	MDP
7	01	LATERAL DIREITA	1700X340X15	MDP
8	05	PRATELEIRA MENOR	320X200X15	MDP
9	01	FUNDO LATERAL	1700X205X15	MDP
10	01	TAMPO	680X360X15	MDP
11	01	FUNDO TRASEIRO	1725X458X3	MDF
12	01	PORTA	1695X460X15	MDP
13	01	ESPELHO	1600X350X3	MDP

■ SAPATEIRA LISBOA



MANUAL DE MONTAGEM

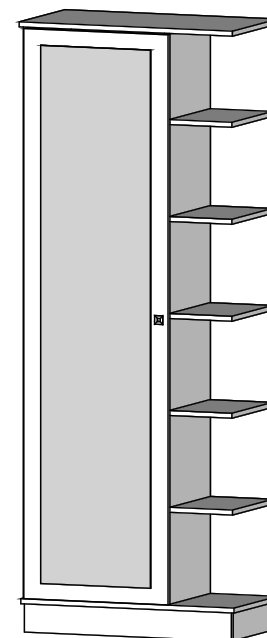

A: 1820 mm
L: 680 mm
P: 360 mm

⚠ ATENÇÃO



LER E OBSERVAR ATENTAMENTE TODA INSTRUÇÃO ANTES DE INICIAR A MONTAGEM

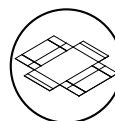

ACONSELHAMOS UTILIZAR A EMBALAGEM PARA FORRAR O CHÃO A FIM DE NÃO DANIFICAR O PRODUTO

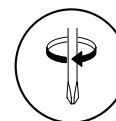

OS PARAFUSOS DEVEM SER APERTADOS PERIODICAMENTE



EVITAR BATIDAS



EVITAR OBJETOS CORTANTES

RECOMENDAÇÕES DE USO:

- 1- o produto deve ser transportado em sua embalagem para que sejam preservadas suas características;
- 2- a limpeza e manutenção do produto deve ser feita com pano úmido, sem adição de produtos químicos;
- 3- a montagem deve atender aos passos especificados no roteiro de montagem, que se encontra anexo ao produto;
- 4- não colocar arranjos, ornamentos, enfeites ou outros objetos superior a 5 kg no tampo;
- 6- evitar locais úmidos ou com excessiva luz do sol, para maior durabilidade do produto.



LIMPEZA:

- 1- pano levemente umedecido com água, seguido de pano seco;
- 2- não utilizar produtos químicos ou abrasivos.

■ Conferir as medidas dos parafusos e acessórios na escala abaixo antes de utilizá-los nas peças.

MEDIDAS EM mm



1

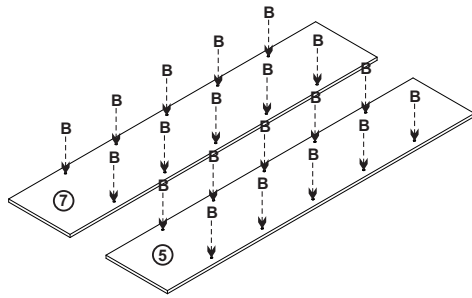

2

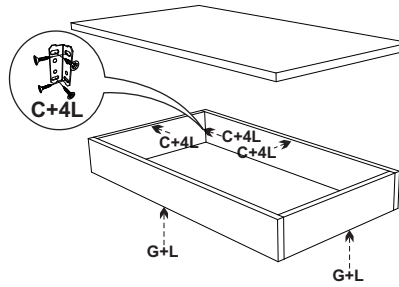

3

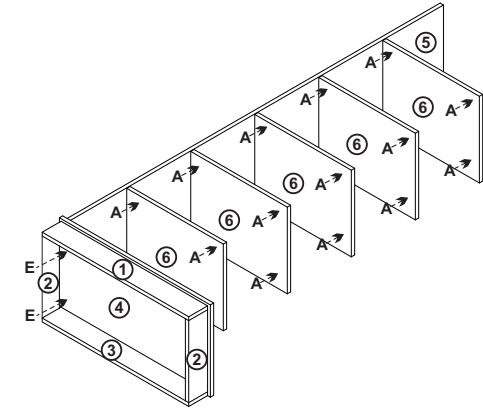

5

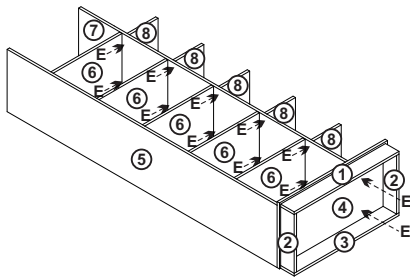

6

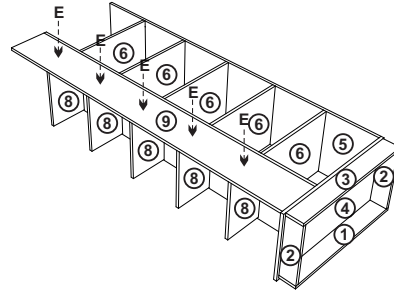

7

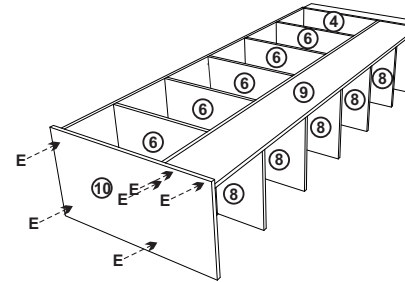

8

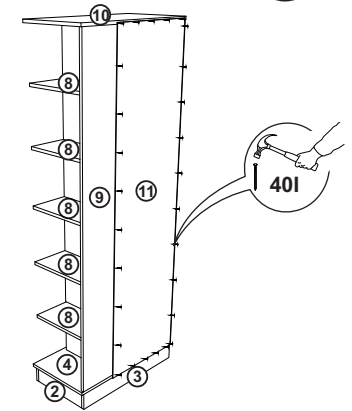

9

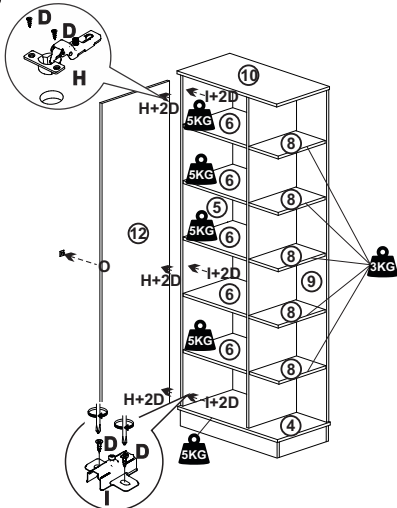

10

ADVERTÊNCIA:
 IMPRESCINDÍVEL A FIXAÇÃO DO PRODUTO COM A CANTONEIRA NA PAREDE, O MESMO NÃO PODE SER UTILIZADO SE ESTE ACESSÓRIO NÃO FOR COLOCADO. A NÃO COLOCAÇÃO DESTA, PODERÁ PERMITIR QUE O PRODUTO VIRE, CAUSANDO ACIDENTE

ATENÇÃO: IMPORTANTE FIXAR A SAPATEIRA NA PAREDE COM A CANTONEIRA 2 FUROS:

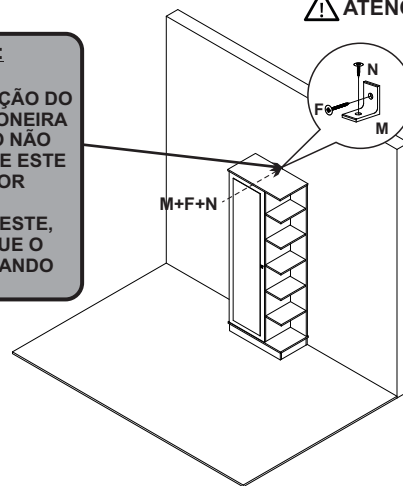

QUANTIDADE DE PESSOAS NECESSÁRIAS



FERRAMENTAS NECESSÁRIAS

