

# Peroba

## Móveis Infantis

### MANUAL DE INSTRUÇÕES

### ARMÁRIO JUNIOR/SMIM/ULI/BOLINHA/TEDY/LUNA 2PT NEW

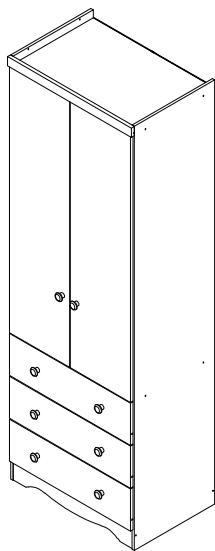

JUNIOR NEW Código: 4711  
SMIM NEW Código: 5017

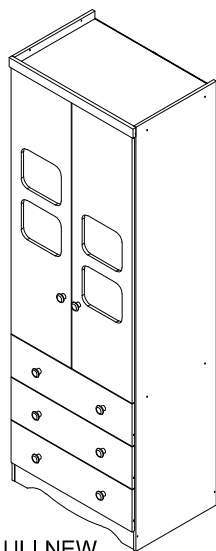

ULI NEW  
Código: 5014

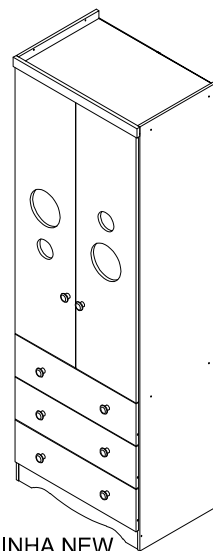

BOLINHA NEW  
Código: 5013

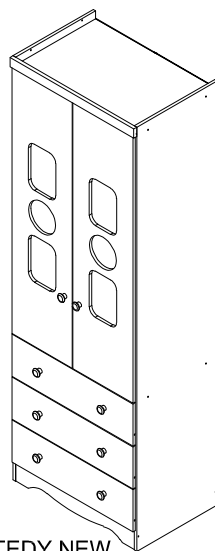

TEDY NEW  
Código: 5015

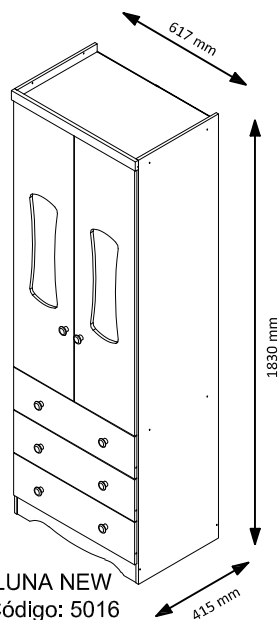

LUNA NEW  
Código: 5016

INDÚSTRIA DE MÓVEIS PEROBA LTDA - CNPJ: 06.368.547/0001-20  
Avenida dos Moveleiros, 1895, Bairro Canivete, Linhares-ES, CEP: 29.909-120  
Tel: (27) 3264-7901 / Cel: (27) 9 8151-3173  
[www.moveisperoba.com.br](http://www.moveisperoba.com.br)

Pág. 01

VERSÃO	DESCRIÇÃO:	ELABOR.:	APROV.:	DATA:	CÓD. DOC.:
01	Elaboração do documento	EPM	PHB	25/05/2023	5012

# 1. TERMO DE GARANTIA

A Indústria de Móveis Peroba Ltda garante a qualidade de seus produtos quanto à defeitos e vícios de fabricação, conforme a Lei 8.078/90 (CÓDIGO DE DEFESA DO CONSUMIDOR), nos limites aqui estabelecidos:

1º - Este produto possui **03 (três) meses de garantia legal**. Esse prazo inicia-se na data de entrega do produto.

2º - Entende-se por garantia o reparo gratuito do item comprado, que apresente defeito ou vício de fabricação, de acordo com parecer técnico da Indústria de Móveis Peroba Ltda. Essa garantia somente terá validade mediante a apresentação de uma prova de compra válida.

3º - Para o exercício da presente garantia, o consumidor deverá solicitá-la à loja onde adquiriu o produto, para que a mesma solicite o reparo junto ao fabricante.

4º - Caso seja necessário reparo do produto adquirido, o prazo para devolução do produto, peça ou acessório consertado é de **até 30 dias**.

5º - Todos os produtos devem ser conferidos no momento da entrega.

**6º - Não estão cobertos por esta garantia (ônus do consumidor):**

**a) DANOS DECORRENTES DE MONTAGEM/INSTALAÇÃO INADEQUADA, ASSIM COMO O NÃO CUMPRIMENTO DAS ORIENTAÇÕES CONTIDAS NESSE MANUAL.**

b) Danos causados por acidentes, tais como quedas, batidas, desabamentos, incêndios, entre outros, após a instalação do produto.

c) Danos provocados por exposição à umidade, luz solar direta, salinidade, ataque de pragas biológicas decorrentes do ambiente de armazenamento/montagem, após a instalação do produto.

d) Danos decorrentes de limpeza e manutenção inadequados.

e) Danos causados pela colocação de objetos que sejam apoiados, encostados, fixados ou se utilizem do produto como base para sustentação.

f) Danos decorrentes do uso inadequado do produto;

g) Serviços de modificação de local após a instalação do produto, modificação de cor, alteração de medidas e estrutura, modificações de modelo;

h) Roubo ou furto.

**PREENCHA OS DADOS A SEGUIR:**

Data da compra: \_\_\_\_/\_\_\_\_/\_\_\_\_ Número da Nota Fiscal: \_\_\_\_\_ Número do lote: \_\_\_\_\_

**No caso de assistência técnica, entrar em contato com a loja onde adquiriu o produto.**

**Guarde sempre a Nota fiscal e este manual, pois são partes fundamentais para o atendimento da garantia.**

## 2. LIMPEZA E CONSERVAÇÃO

a) Na limpeza de rotina utilize somente um pano limpo e macio, ligeiramente umedecido em água (apenas o bastante para remover a poeira), seguido de um pano seco. Para sujeiras mais difíceis, utilize um pano ligeiramente umedecido com um pouco de sabão neutro, também seguido de um pano seco e macio.

a.1) Nunca utilize:

- Pano encharcado, pois o acúmulo de água causa danos ao móvel;
- Pano de cozinha (louça), pois pode conter resíduos de gordura;
- Material pontiagudo, cortante ou abrasivo, como estiletes, esponjas de aço ou esponjas abrasivas, pois podem arranhar a pintura;
- Lustra móveis colorido ou com cera, porque podem manchar o acabamento do móvel;
- Diluentes, limpadores instantâneos, produtos de limpeza a base de amônia ou saponáceo, porque estes produtos químicos podem danificar o acabamento;

b) Evite a incidência de luz solar direta sobre o móvel, pois isso pode desbotar o acabamento com o tempo.

c) Não exponha o móvel a ambientes com excesso de umidade ou próximo a paredes com bolor ou mofo.

d) Sempre deixe os móveis a uma distância de 3,0 a 5,0 cm de distância das paredes, para permitir a circulação de ar.



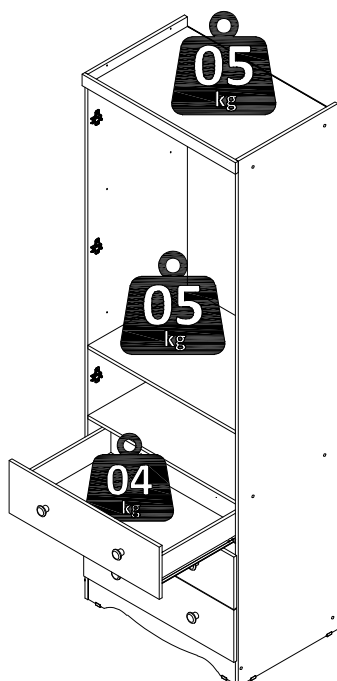

e) Respeite os limites de peso suportados pelo móvel:

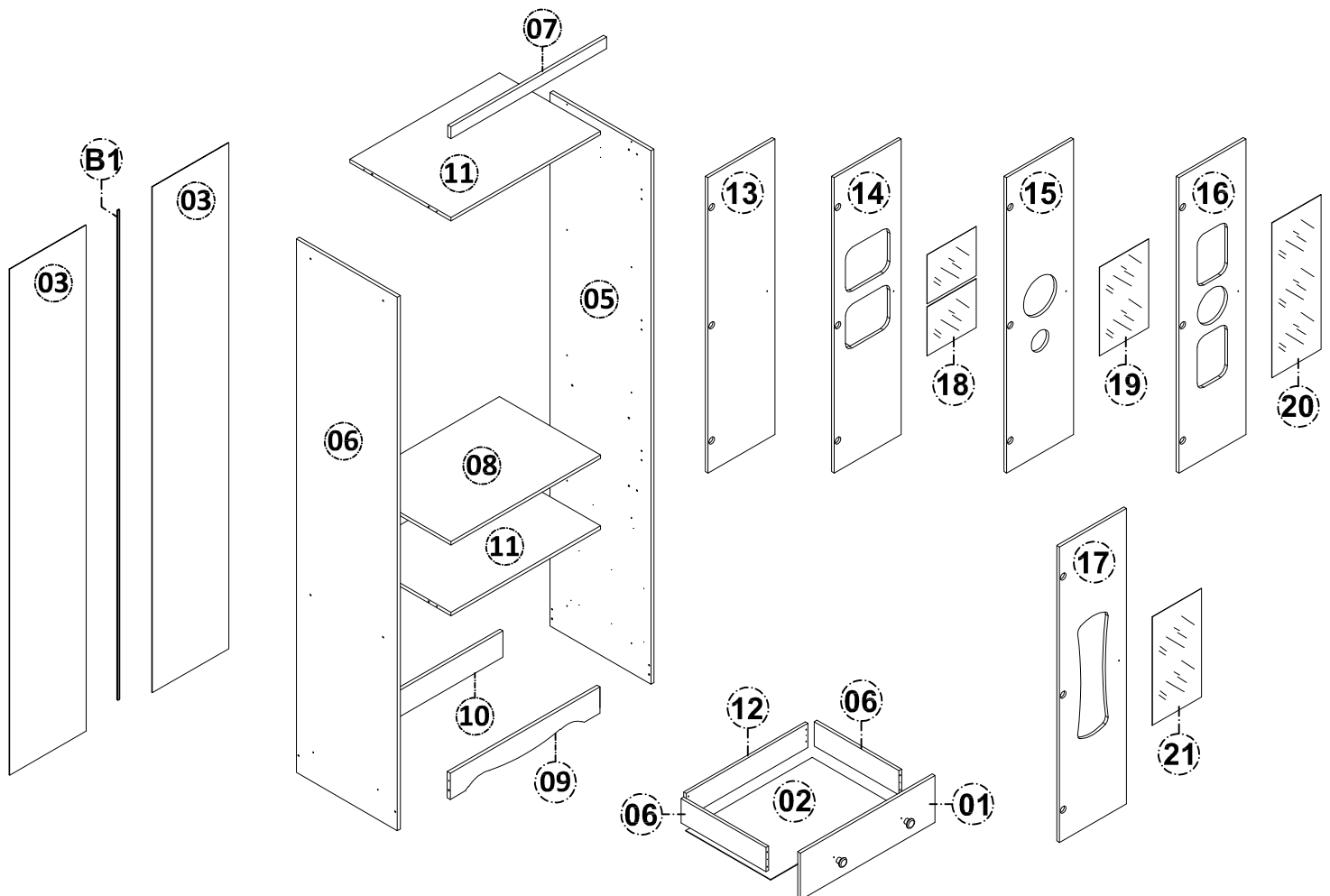

### 3. IDENTIFICAÇÃO DAS PEÇAS, ACESSÓRIOS E FERRAGENS

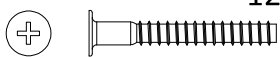
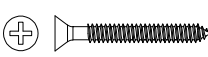
ITEM	DESCRIÇÃO	DIMENSÕES (mm)						CORES	
		COMP	LARG	ESP	MAT	QTD	CÓD	Branco BRI	Carv./Branco BRI
01	Frete gaveta	602	182	12	MDF	03	4697	Branco BRI	Branco BRI
02	Fundo gaveta	572	397	2,5	MDF	03	4700	Branco	Branco
03	Fundo traseiro armário	1735	305	2,5	MDF	02	24	Branco	Branco
04	Lateral direita	1830	400	12	MDF	01	4709	Branco BRI	Carvalho
05	Lateral esquerda	1830	400	12	MDF	01	5094	Branco BRI	Carvalho
06	Lateral gaveta	380	96	12	MDF	06	4698	Branco	Branco
07	Moldura	617	40	12	MDF	01	4710	Branco BRI	Carvalho
08	Prateleira móvel	593	400	12	MDF	01	13	Branco	Branco
09	Rodapé torneado	593	90	12	MDF	01	183	Branco BRI	Carvalho
10	Rodapé reto	593	90	12	MDF	01	184	Cru	Cru
11	Tampo superior/gaveteiro	593	400	12	MDF	02	4693	Branco	Branco
12	Traseiro gaveta	573	96	12	MDF	03	4699	Branco	Branco
<b>Modelo Porta</b>									
13	Porta Junior New   Smim New	1146	300	12	MDF	02	4936	Branco BRI/Branco	Branco BRI/Branco
14	Porta Usinada Uli New	1146	300	12	MDF	02	4638	Branco BRI/Branco	Branco BRI/Branco
15	Porta Usinada Bolinha New	1146	300	12	MDF	02	4937	Branco BRI/Branco	Branco BRI/Branco
16	Porta Usinada Tedy New	1146	300	12	MDF	02	4939	Branco BRI/Branco	Branco BRI/Branco
17	Porta Usinada Luna New	1146	300	12	MDF	02	4940	Branco BRI/Branco	Branco BRI/Branco
<b>Modelo Acrílico</b>									
18	Acrílico Uli New	220	190	1,5	PETG	04	0102	Cristal	Cristal
19	Acrílico Bolinha New	325	176	1,5	PETG	02	0100	Cristal	Cristal
20	Acrílico Tedy New	656	159	1,5	PETG	02	0103	Cristal	Cristal
21	Acrílico Luna New	482	155	1,5	PETG	02	0117	Cristal	Cristal

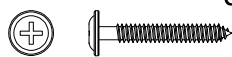
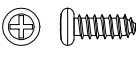
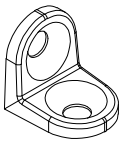
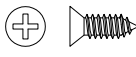
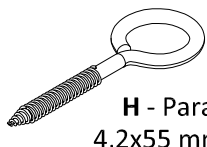
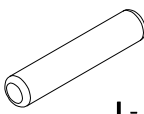
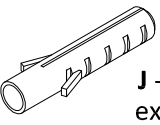
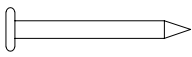
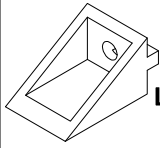
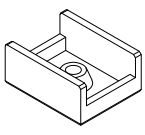
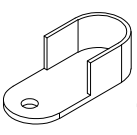
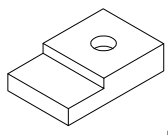
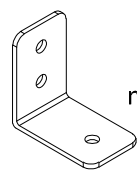
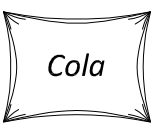
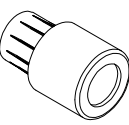
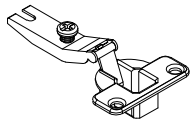
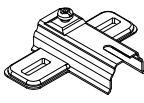
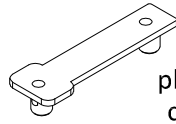
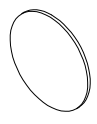
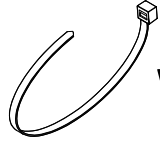
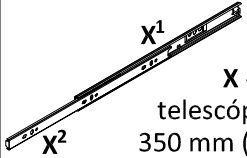
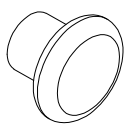
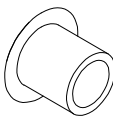
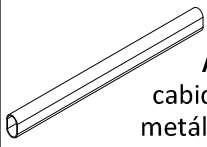

 <p><b>A</b> - Parafuso chato estrutural philips 5x40 s/ ponta (cód. 2232)</p> <p>12un</p>	 <p><b>B</b> - Parafuso chato philips 3,5x35 c/ ponta (cód. 2235)</p> <p>06un</p>	 <p><b>C</b> - Parafuso flangeado philips 3,5x12 c/ ponta (cód. 2270)</p> <p>16un</p>	 <p><b>D</b> - Parafuso flangeado philips 3,5x30 c/ ponta (cód. 2237)</p> <p>08un</p>
 <p><b>E</b> - Parafuso panela philips 4x11 s/ ponta (cód. 2259)</p> <p>12un</p>	 <p><b>F</b> - Cantoneira metálica com furos 13x13 mm (cód. 3105)</p> <p>06un</p>	 <p><b>G</b> - Parafuso chato philips 3,5x10 c/ ponta (cód. 2233)</p> <p>82un</p>	 <p><b>H</b> - Parafuso pitão 4,2x55 mm (cód. 2240)</p> <p>01un</p>
 <p><b>I</b> - Cavilha madeira 6x30 mm (cód. 2225)</p> <p>30un</p>	 <p><b>J</b> - Bucha plástica expansiva 06 mm (cód. 2224)</p> <p>01un</p>	 <p><b>K</b> - Prego 10x10 (cód. 2241)</p> <p>104un</p>	 <p><b>L</b> - Suporte angular plástico 45x20x20 (cód. 2486)</p> <p>03un</p>
 <p><b>M</b> - Sapata plástica "U" 12X12 mm (cód. 2292 BR   2293 CAR)</p> <p>08un</p>	 <p><b>N</b> - Suporte metálico p/ tubo cabideiro 45x20x12 mm (cód. 2243)</p> <p>02un</p>	 <p><b>O</b> - Suporte plástico p/ acrílico 15x10 mm (cód. 2244)</p> <p>24un</p>	 <p><b>P</b> - Cantoneira metálica 03 furos 30x18 mm (cód. 2291)</p> <p>01un</p>
 <p><b>Q</b> - Cola sachet 10g (cód. 2454)</p> <p>01un</p>	 <p><b>R</b> - Suporte plástico p/ prateleira 8x10 mm (cód. 2245)</p> <p>04un</p>	 <p><b>S</b> - Dobradiça metálica caneco 26 mm (cód. 2227)</p> <p>06un</p>	 <p><b>T</b> - Calço metálico 05 mm alt. p/ dobradiça 26 mm (cód. 2257)</p> <p>06un</p>
 <p><b>U</b> - Bucha plástica dupla p/ calço dobradiça 42x13 (cód. 2258)</p> <p>06un</p>	 <p><b>V</b> - Tampa furo adesivo 15 mm (cód. 2341 BR   2442 CAR)</p> <p>14un</p>	 <p><b>W</b> - Abraçadeira nylon 200 mm (cód. 2223)</p> <p>01un</p>	 <p><b>X</b> - Corrediça telescópica 02 est. 350 mm (cód. 1507)</p> <p>03 Pares</p>
 <p><b>Y</b> - Puxador plástico bolinha 30x35 mm (cód. 65 BR   66 CAR)</p> <p>08un</p>	 <p><b>Z</b> - Tampa furo 05 mm (cód. 2247 BR   2295 CAR)</p> <p>09un</p>	 <p><b>A1</b> - Tubo cabideiro oblongo metálico 582x25x16 (cód. 69)</p> <p>01un</p>	 <p><b>B1</b> - Perfil plástico p/ união de fundos 1735x15x5mm (cód. 70 BR)</p> <p>01un</p>

## 4. FERRAMENTAS NECESSÁRIAS PARA MONTAGEM



01 Montador  
(Não Incluso)

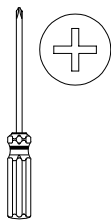

Chave Philips  
(Não Incluso)

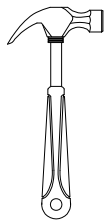

Martelo  
(Não Incluso)

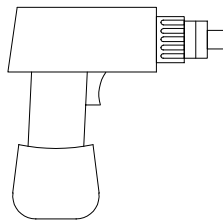

Parafusadeira  
(Não Incluso)

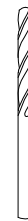

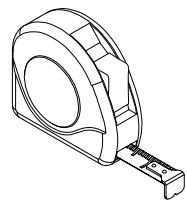

Broca p/  
parede 06 mm  
(Não Incluso)



Trena  
(Não Incluso)

# 5. MONTAGEM PASSO A PASSO

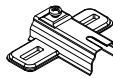
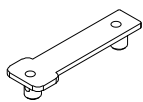
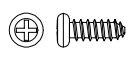
## 1º - PREPARAÇÃO DAS PEÇAS:

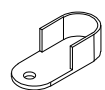
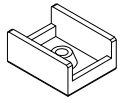
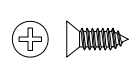
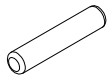
 <b>T</b> 06 un	 <b>U</b> 06 un	 <b>E</b> 12 un	 <b>R</b> 04 un	 <b>X</b> 03 un	 <b>N</b> 02 un
 <b>M</b> 08 un	 <b>G</b> 30 un	 <b>I</b> 04 un			

**\* FORRE O LOCAL DA MONTAGEM COM O PRÓPRIO PAPERÃO DA EMBALAGEM \***

1º - Empurre a trava de segurança para cima

2º - Puxe para fora

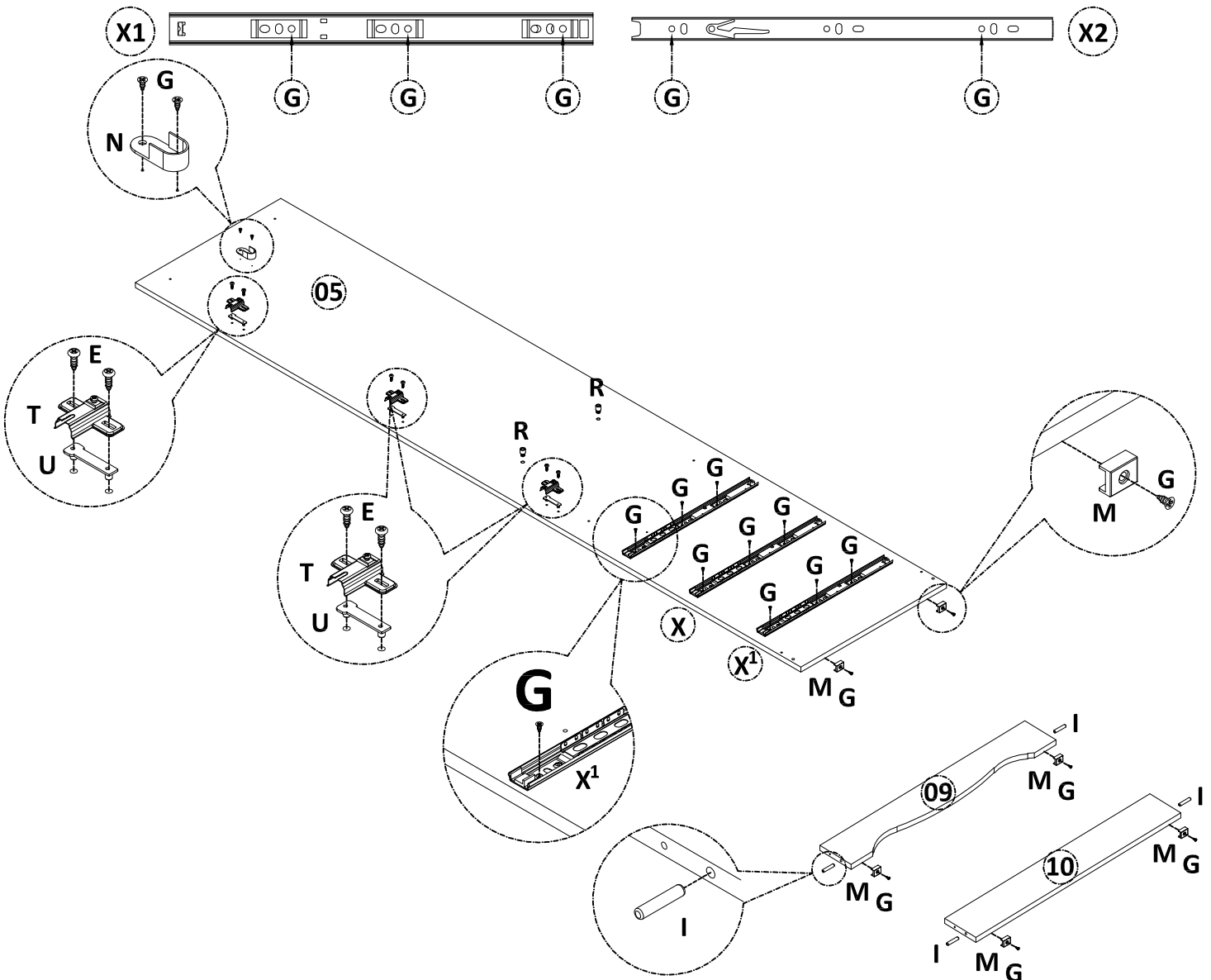
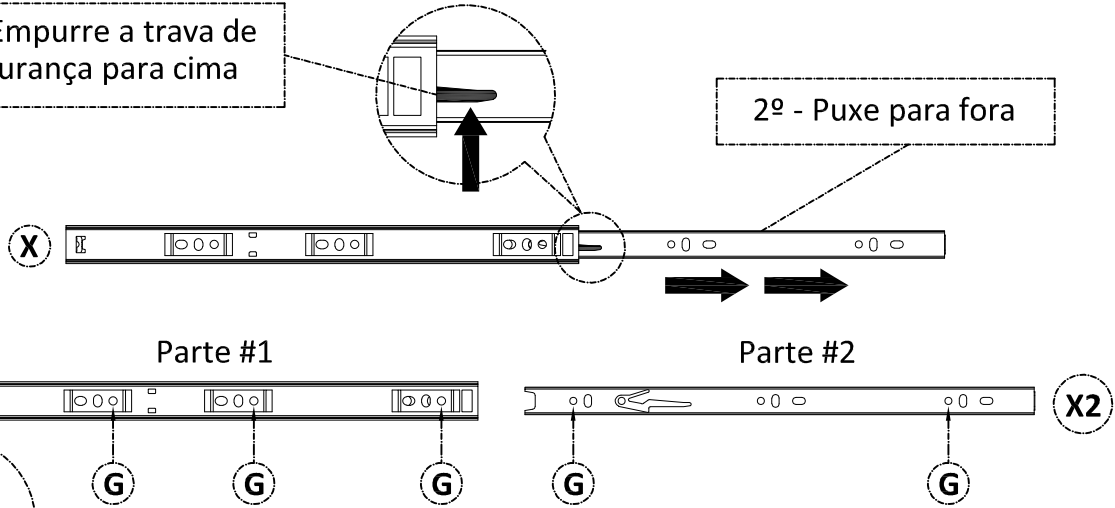

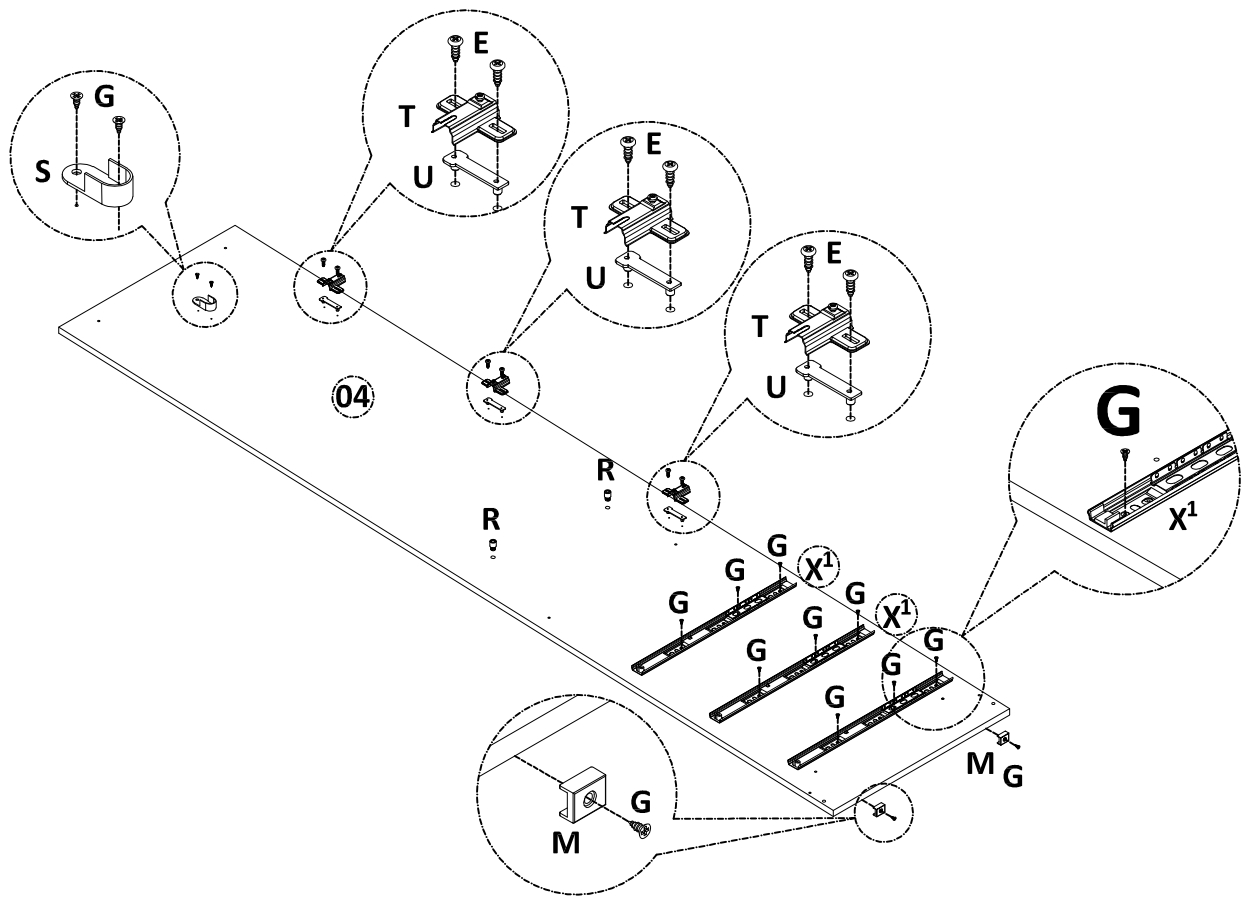



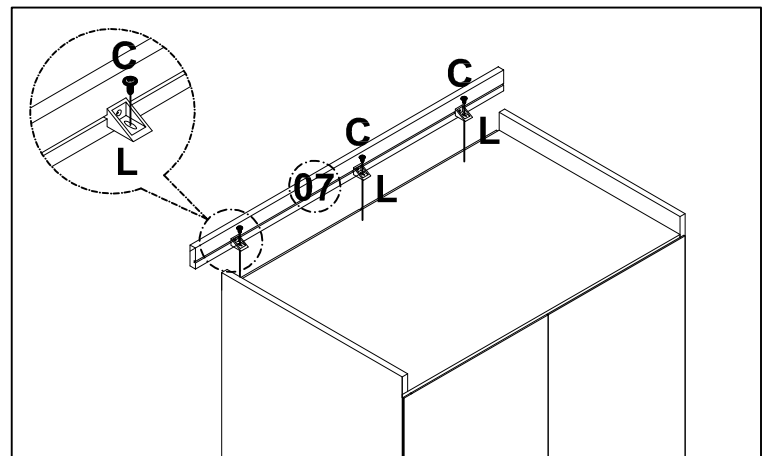
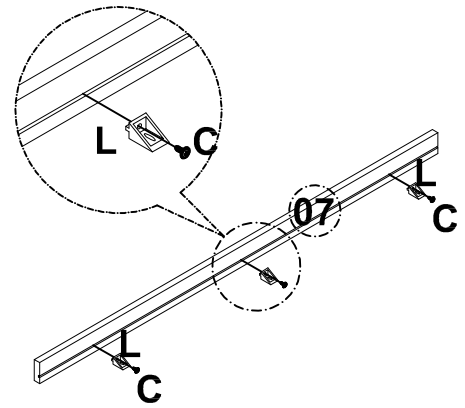
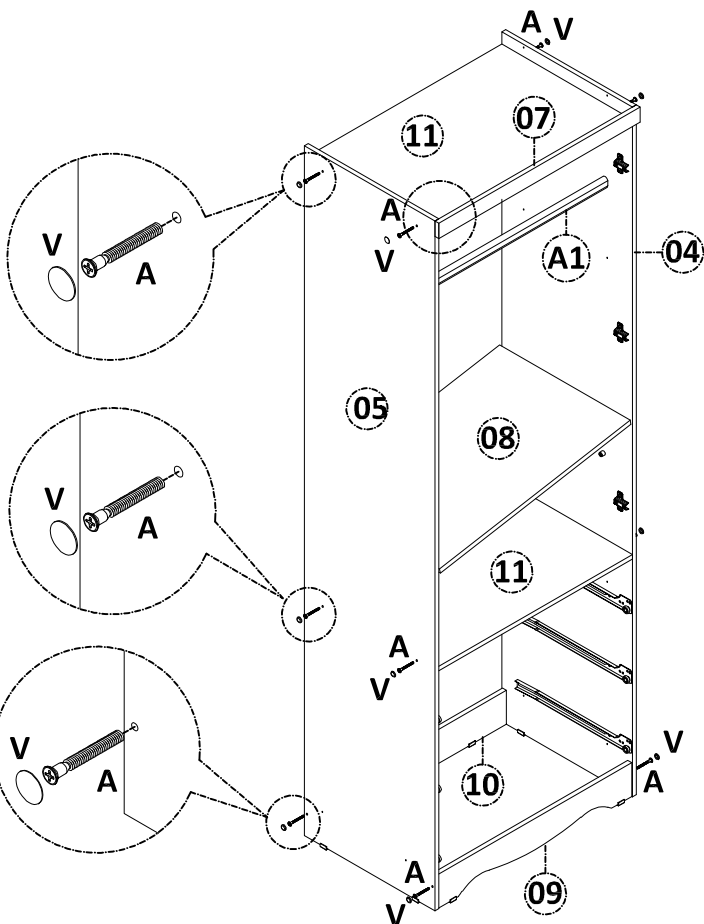
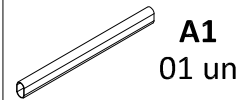
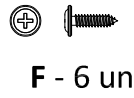
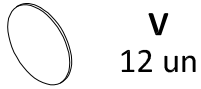
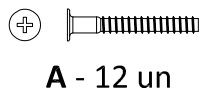

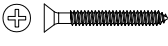

**2º - MONTAGEM DA ESTRUTURA:**

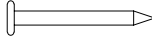

### 3º - MONTAGEM DAS GAVETAS (3X):

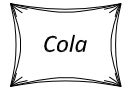
 <b>B</b> - 06 un	 <b>D</b> - 06 un	 <b>G</b> 30 un	 <b>K</b> - 50 un	 <b>I</b> 24 un	 <b>F</b> 06 un
 <b>X2</b> 06 un	 <b>Y</b> 6 un	 <b>Cola</b> <b>Q</b> 1 un			

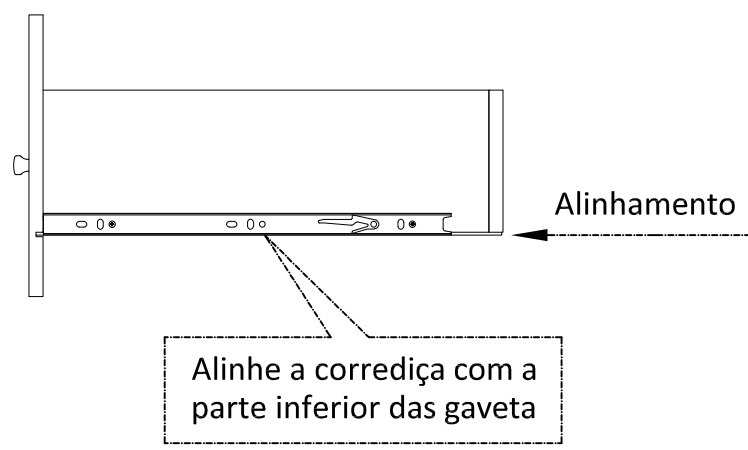
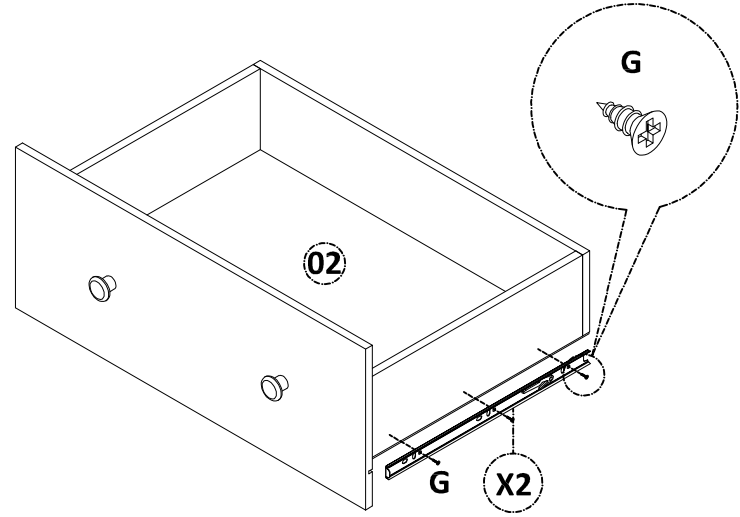
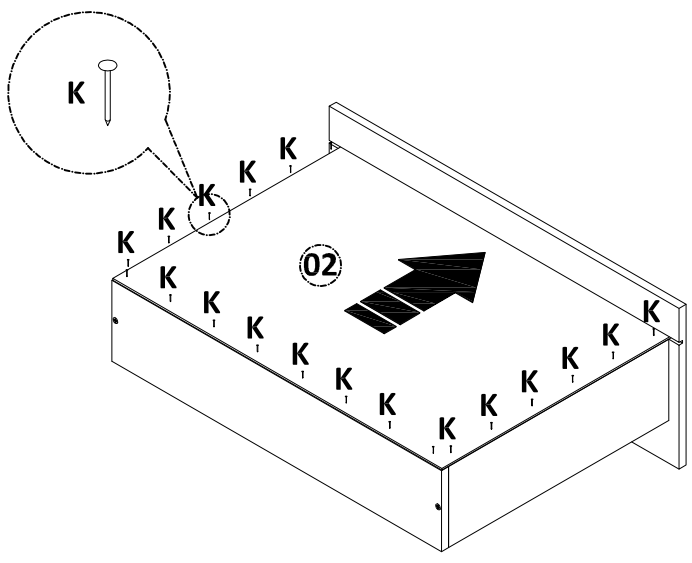
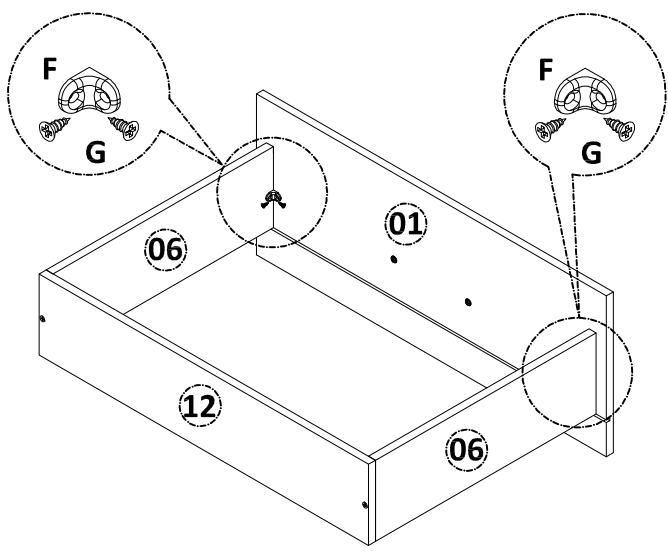
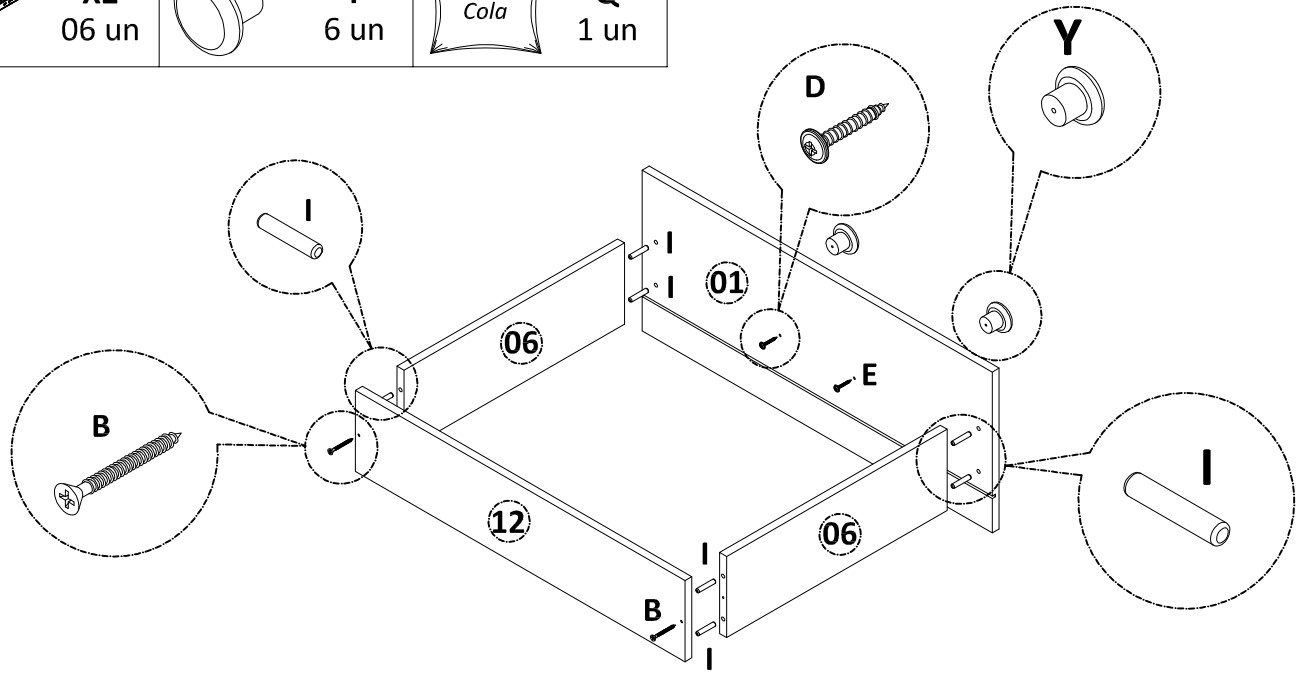



#### 4º - MONTAGEM DAS PORTAS (2X):

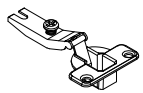

**S**  
06 un

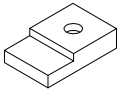

**O**  
12 un

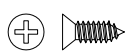

**G**  
24 un



**D - 02 un**



**Y**  
02 un

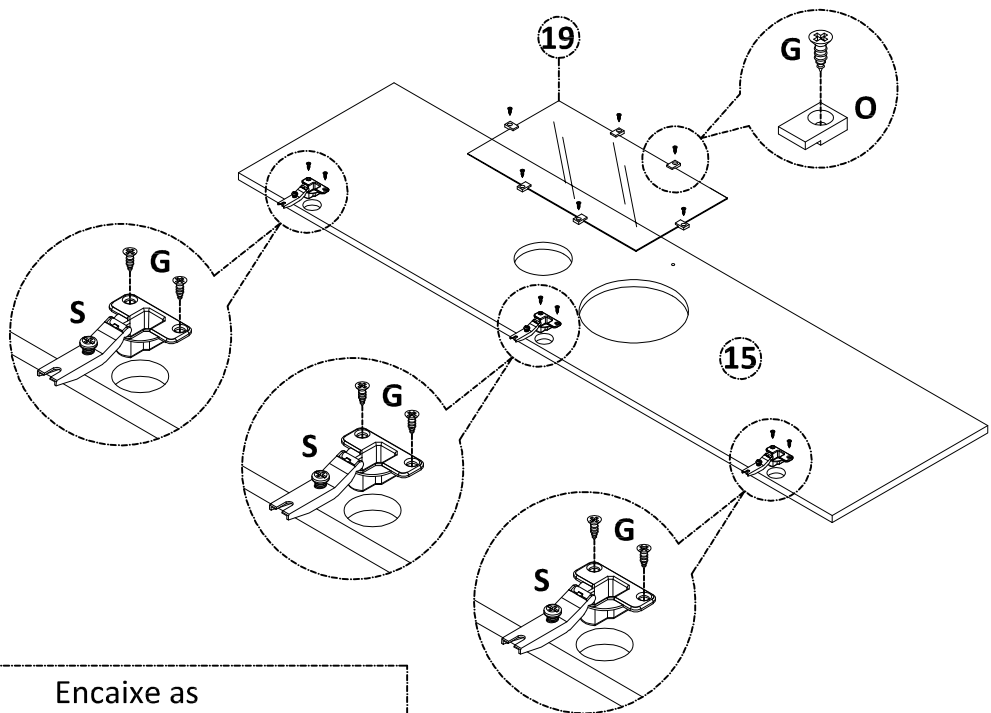

Encaixe as dobradiças nos calços e aperte os parafusos centrais com a chave philips para travar as duas partes

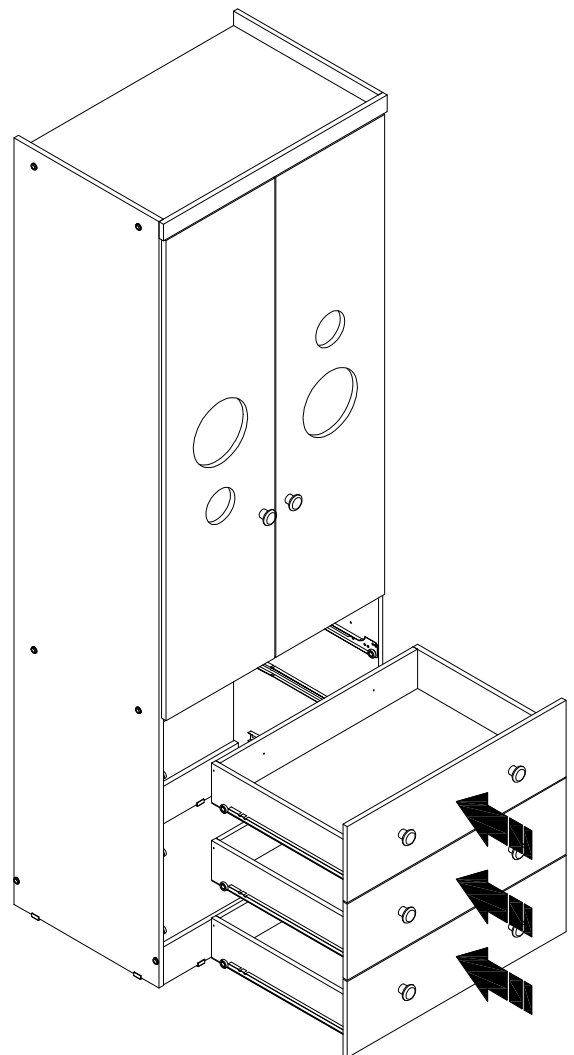
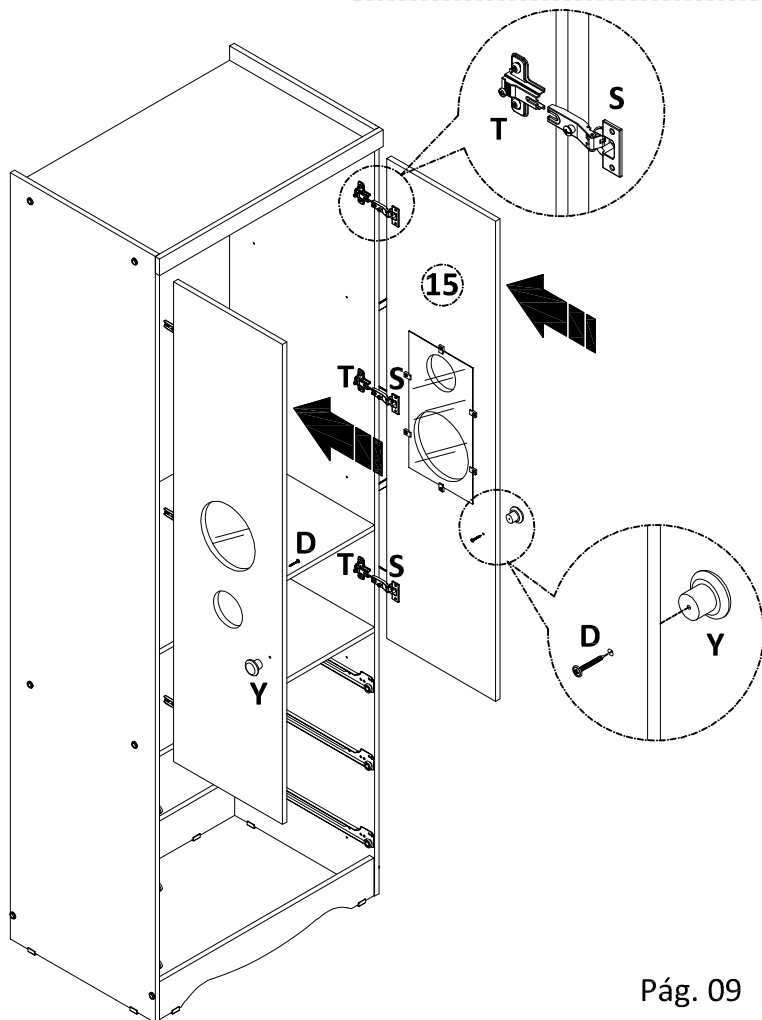
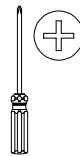

## 5º - FIXAÇÃO DOS FUNDOS TRASEIROS:

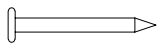

K - 50 un



B1  
01 un

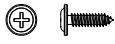

F - 6 un

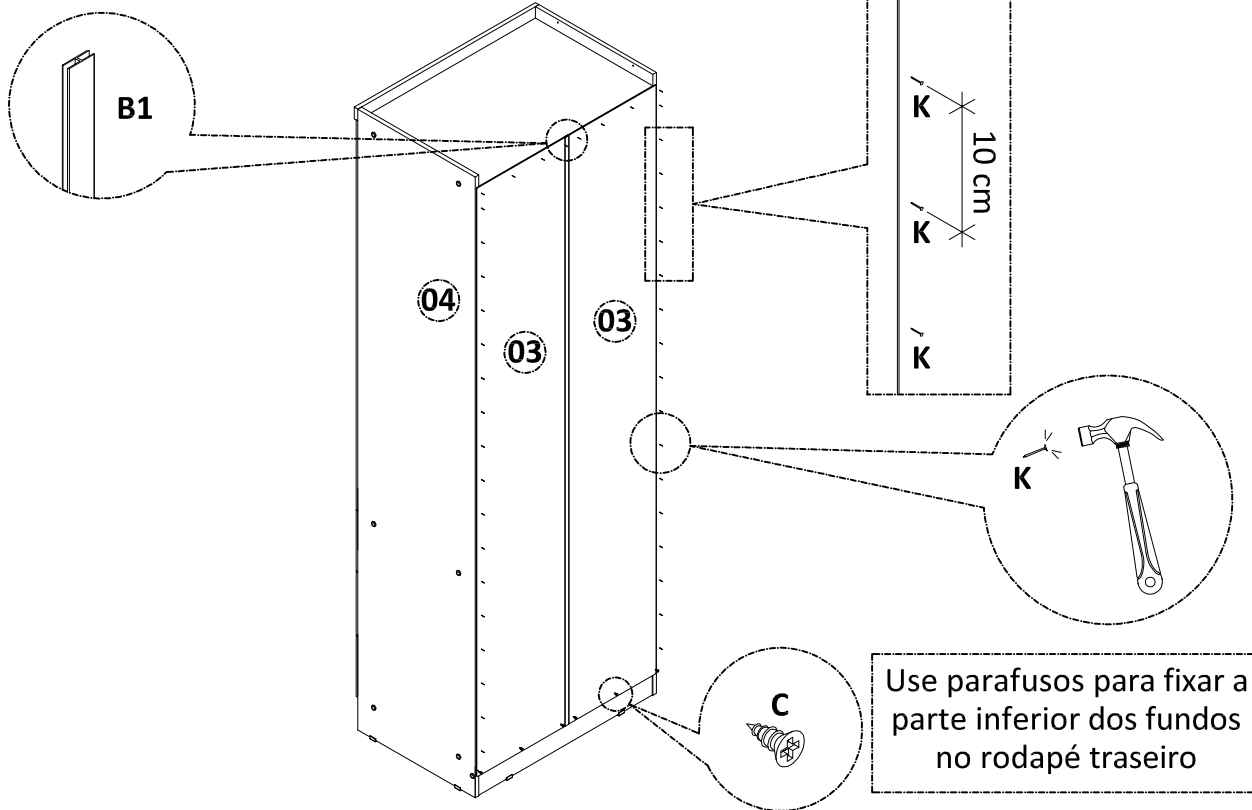

## 6º - MONTAGEM DO SISTEMA ANTITOMBAMENTO:

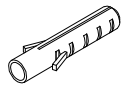

J  
01 un



H  
01 un



P  
01 un

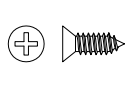

G  
02 un



W  
01 un

